

Product leaflet

Product
Face shield

Model No.
SR 570

Ordering No.
H06-6512

Product Description

The SR 570 face shield together with the battery-powered SR 500 or SR 700 fan and approved filters are included in the Sundström fan-assisted respiratory protection device systems. The breathing hose of the face shield is to be connected to the fan, equipped with filters. The pressure generated in the face shield prevents particles and other pollutants from entering the hood.

The equipment can be used as an alternative to filter respirators in all situations for which filter respirators are recommended. This applies particularly to work that is hard, warm or of long duration.

The characteristics of the SR 570 face shield are as follows:

Protects the breathing zone and the crown of the head • Hinged visor unit • Scratch resistant and chemicals resistant PC visor • Adjustable head harness • Airflow deflector for optimal comfort • The supply air flow keeps the visor demisted • Replaceable breathing air hose • Standard fastener for hearing protection • Optional peel-offs • PC visor and visor frame protects from high speed particles 120 m/s at extremes of temperature, liquid splashes and molten metal • Equipped with an exhalation valve • Available in one size.

Technical specification

SR 570/SR 500/SR 700 EN 12941:1998 +
A2:2008

Air flow rate	175-240 l/min (SR 500) 175-225 l/min (SR 700)	≥ 120 l/min
Service temperature	-10 – +55°C, < 90 % RH	-
Storage temperature	-20 – +40°C, < 90 % RH	-
Low flow warning level	< 175 l/min	≤ 175 l/min
Weight with breathing hose	≈ 850 g	≤ 1 500 g
Impact test with 6 mm dia. steel ball against visor	120 m/s	-
Assigned Protection Factor¹	40 (TH3)	-
Nominal Protection Factor²	500 (TH3)	-
Approvals	EN 12941:1998 + A2:2008 EN 166:2001 EN 812:2012 with Bump cap	-

1) Specified in BS 4275 and applies regardless of the test results.

2) According to EN 529:2005.

- A. SR 570
- C. SR 500
- D. SR 700
- E. Hearing protectors



Head Office

Tel: +46 10 484 87 00

Visiting address:
Stockholmsvägen 33
SE-181 33 Lidingö

Factory

Tel: +46 10 484 87 00

Visiting address:
Västergatan 4
SE-341 50 Lagan

Sundström
www.srsafety.com

SR 570

EN

Spare parts / Accessories

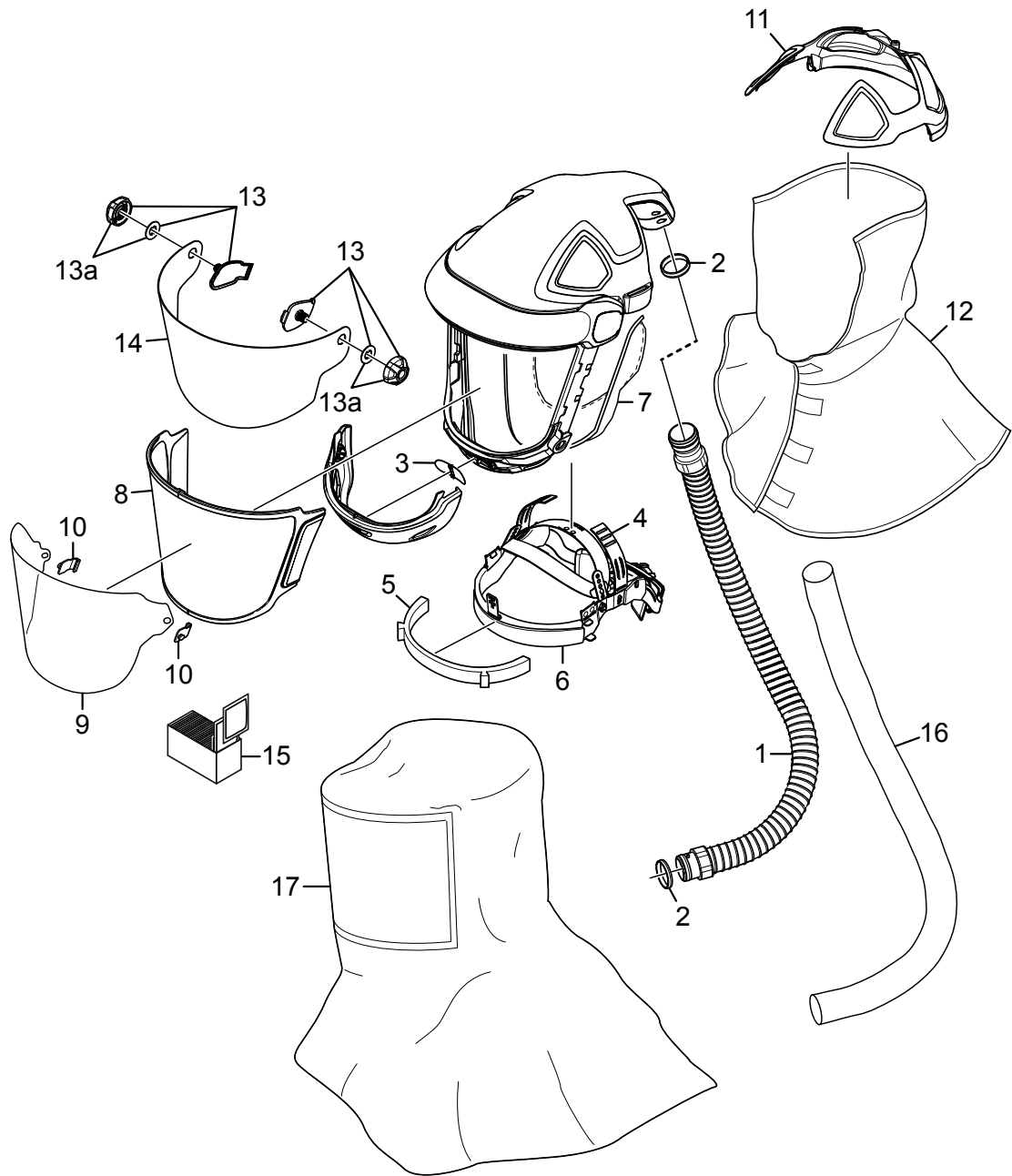

No..	Description	Ordering No.
1.	Breathing hose	R06-0635
2.	Gasket for hose	R01-3011
3.	Exhalation membrane	R06-0614
4.	Head harness	R06-0601
5.	Head harness seal	R06-0610
6.	Sweatband	R06-0602
7.	Face seal	R06-0603
8.	Visor set, PC	R06-0616
9.	Peel-off 10 pcs	T06-0601
	Peel-off 100 pcs	T06-0608
10.	Clips for peel off	T06-0607
11.	Bump cap	T06-0602
12.	Neck cover <i>Note! T06-0602 is required</i>	T06-0603
13.	Cover with thread and knob	T06-0640
13a	Knob complete	R06-0821
14.	Visor 2/3 EN 5	T06-0605
	Visor 2/3 EN 3	T06-0609
	<i>Note! T06-0640 is required</i>	
15.	Cleaning tissues, box of 50	H09-0401
16.	Hose protection, PE	T06-0121
17.	Tyvek Hood SR 586	T06-0806



T06-0602, Bump cap

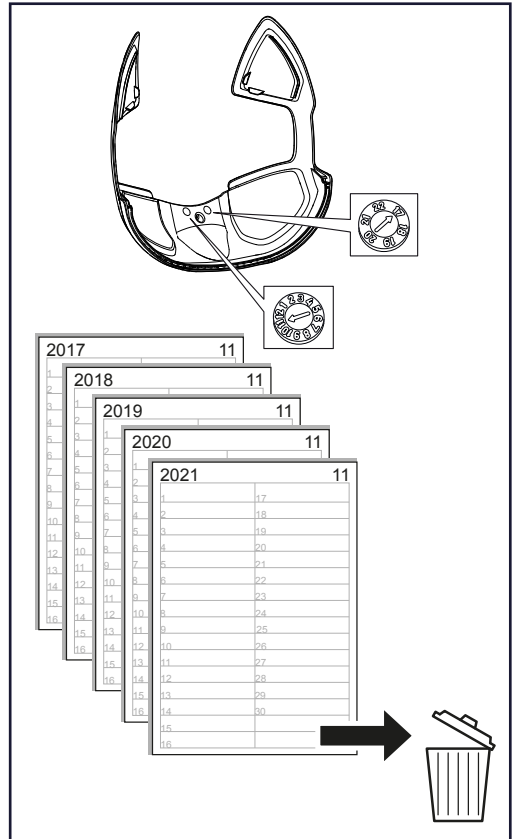
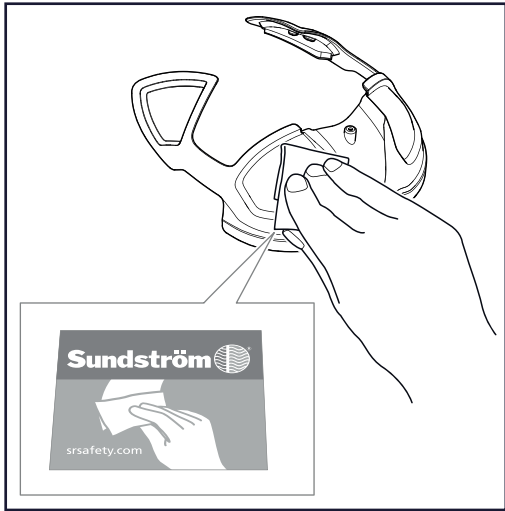
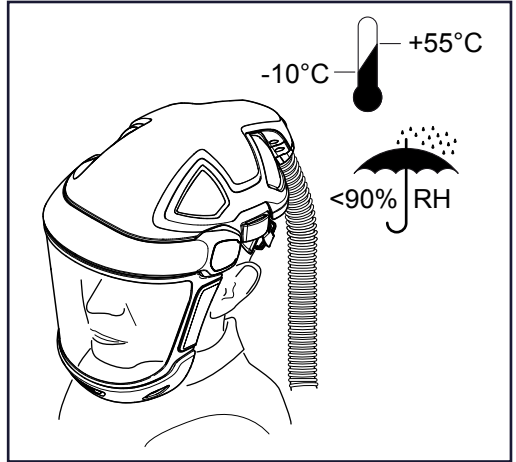
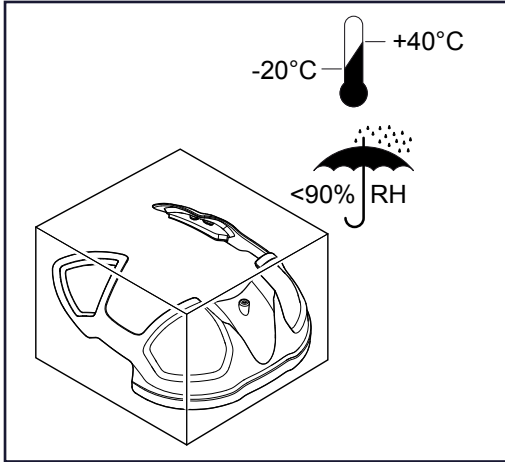

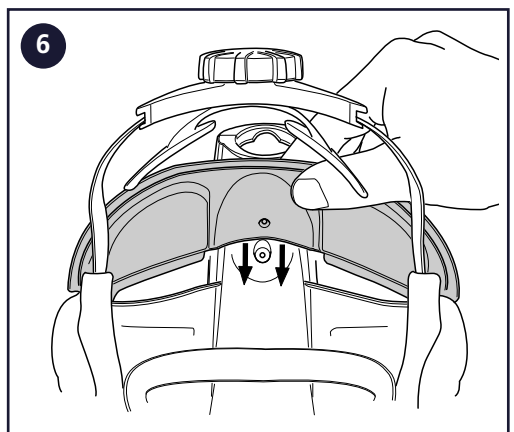
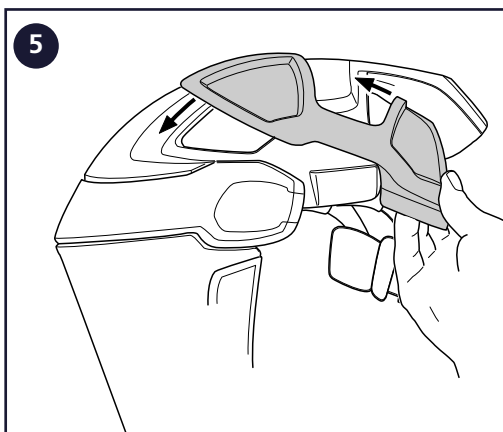
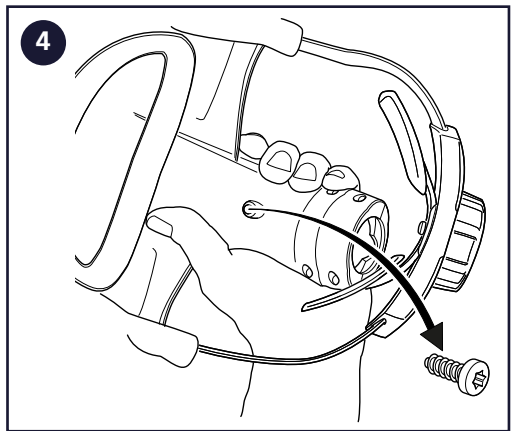
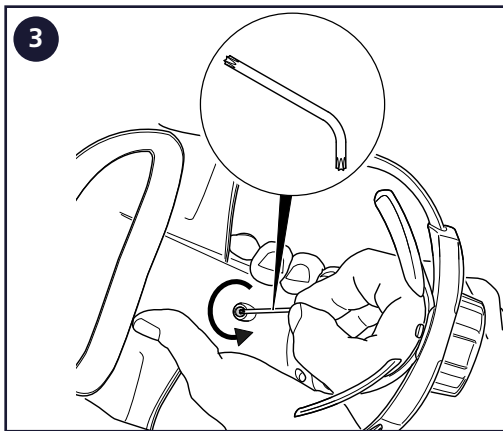
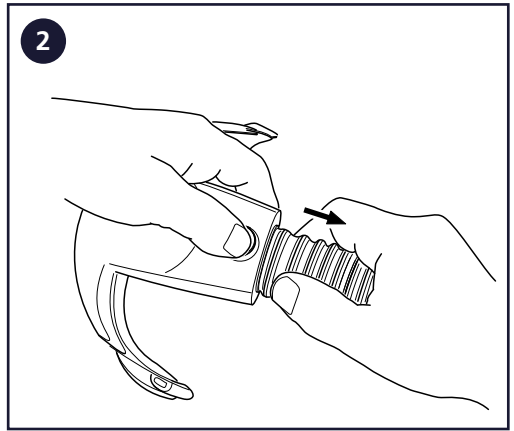
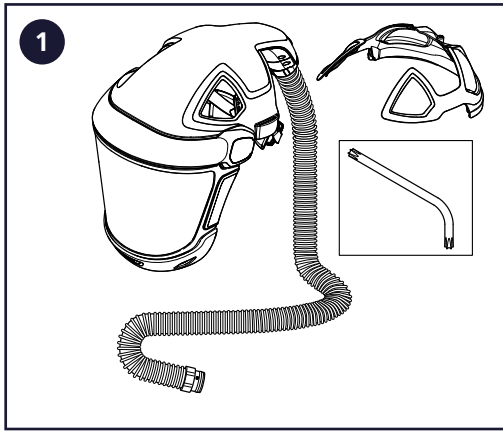
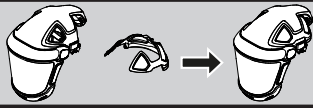

7

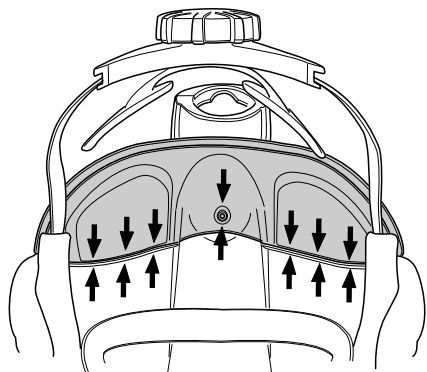

8

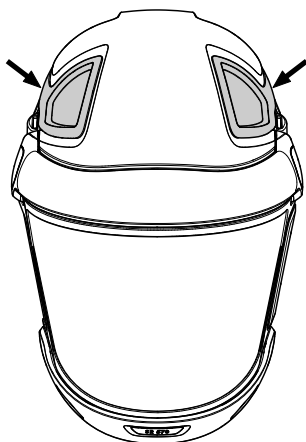

9

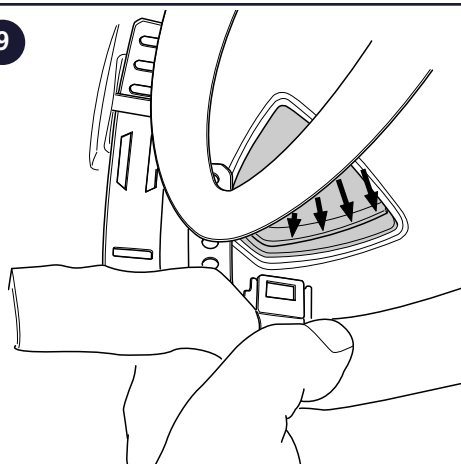

10

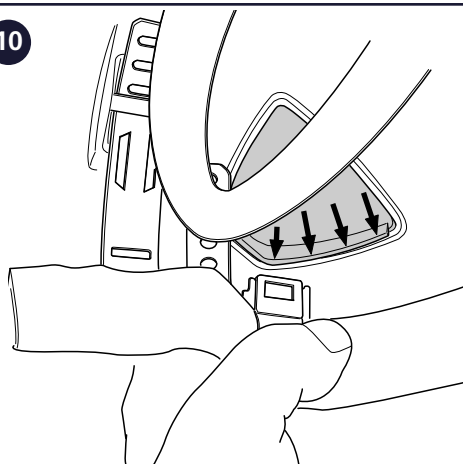

11

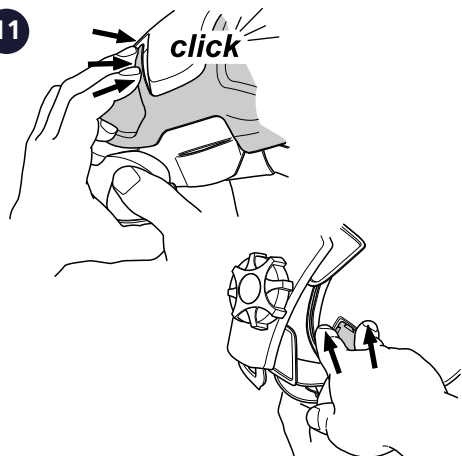

12

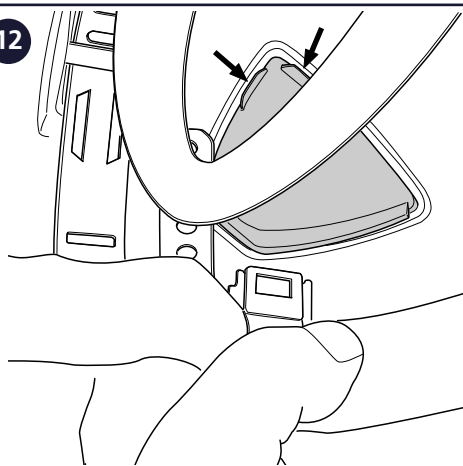

13

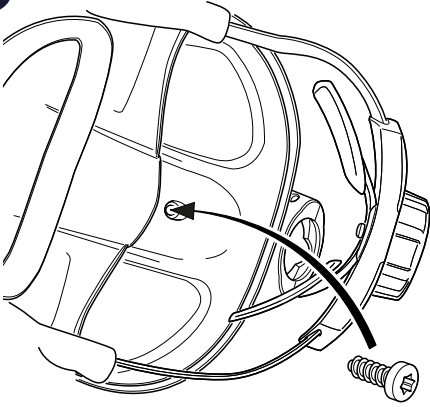

14

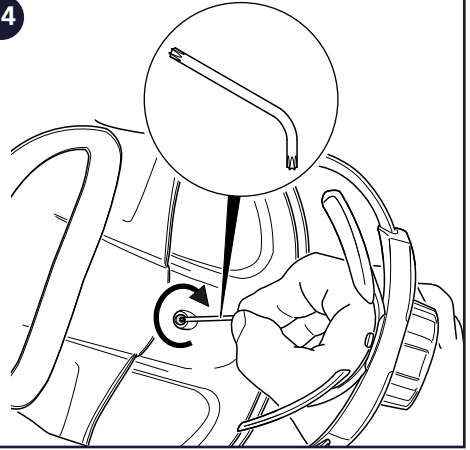

15

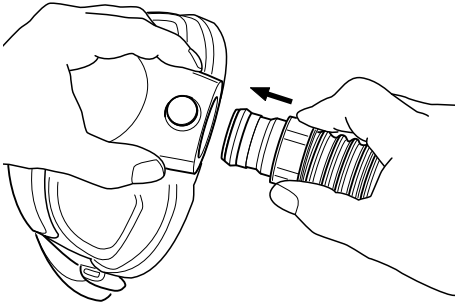

16

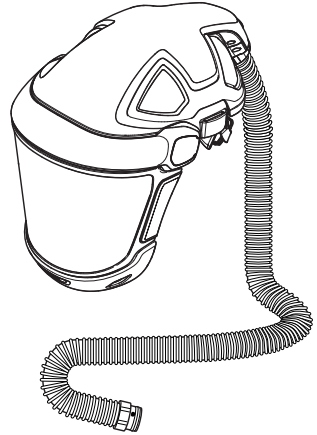

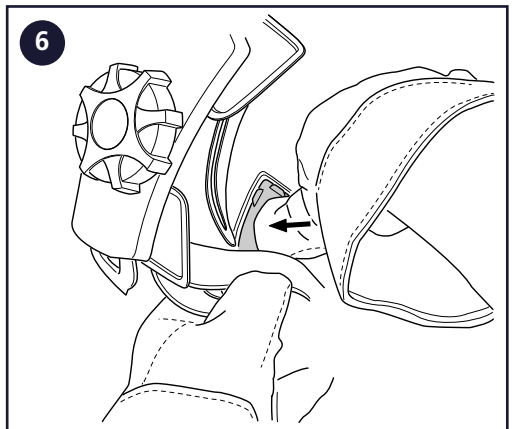
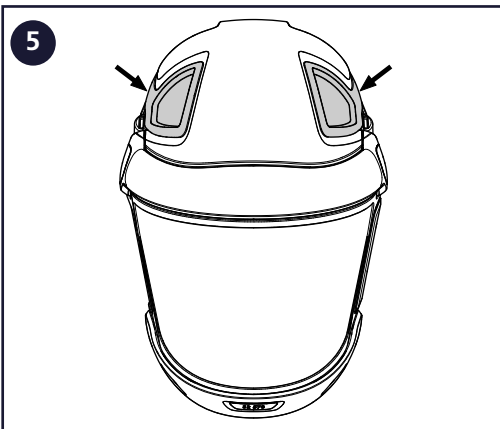
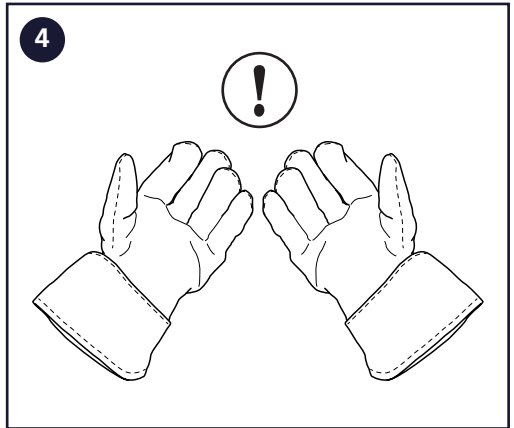
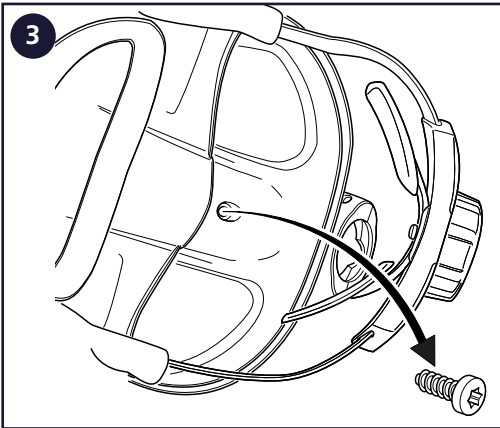
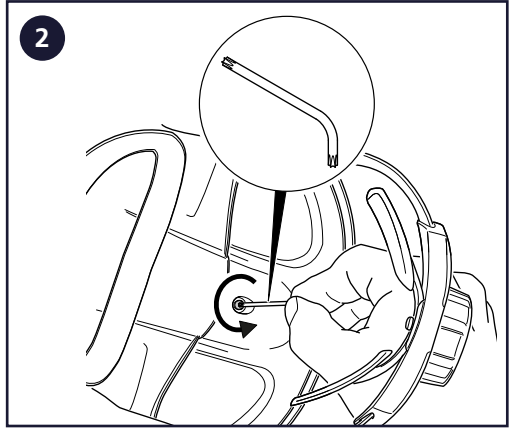
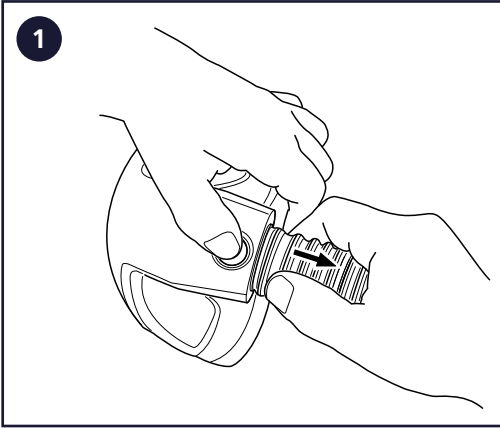
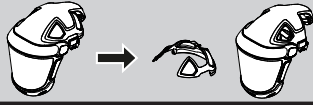

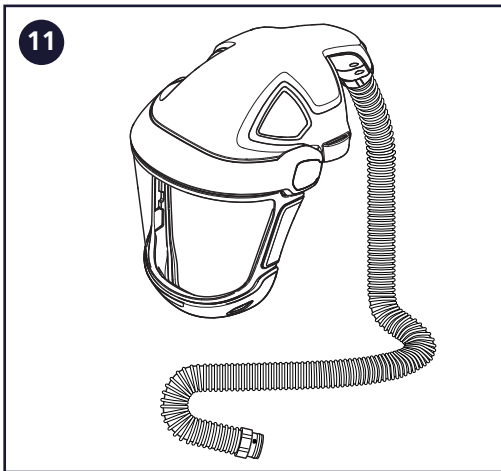
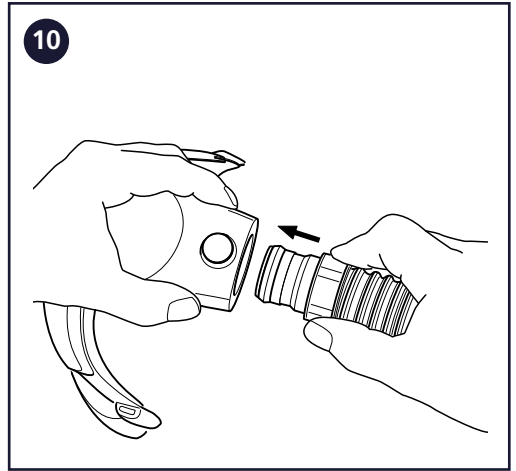
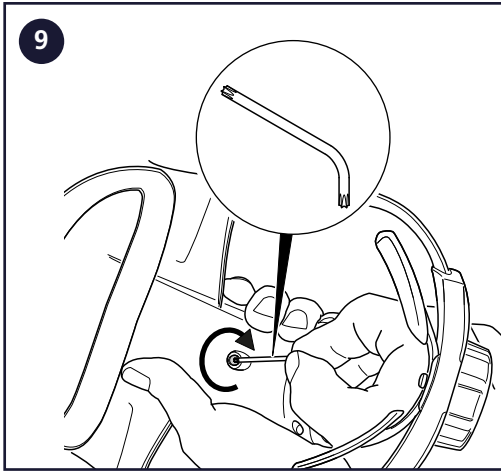
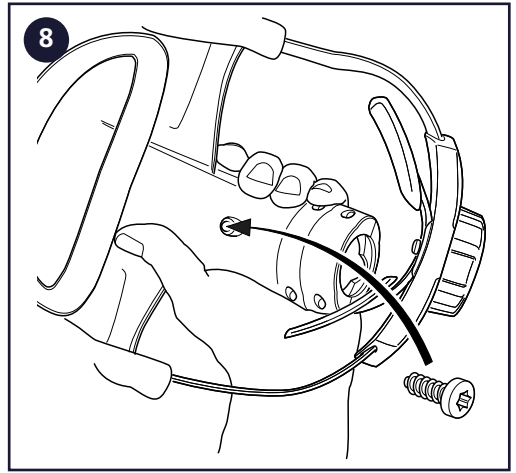
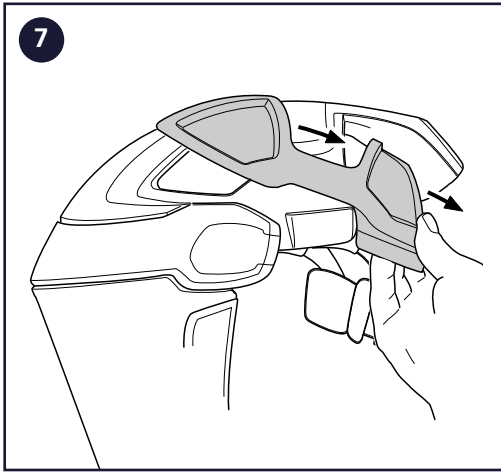

**The Bump cap T06-0602 is manufactured within a
quality management system accepted by
Notified Body 0194: INSPEC International Ltd.
Certification Services, 56 Leslie Hough Way,
Salford, M6 6 AJ, England**



Sundström Safety AB

SE-341 50 Lagan • Sweden

Tel: +46 10 484 87 00

info@srsafety.se • www.srsafety.com



Neck cover for SR 570, T06-0603

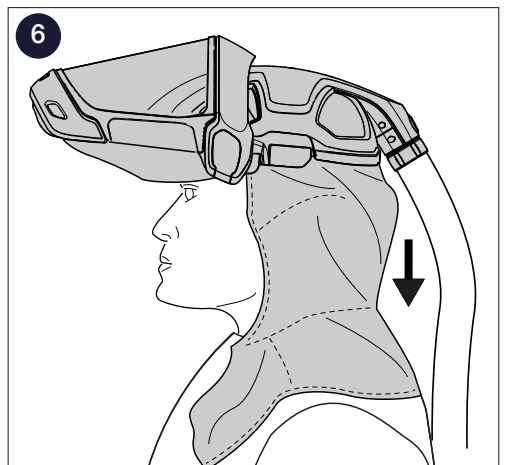
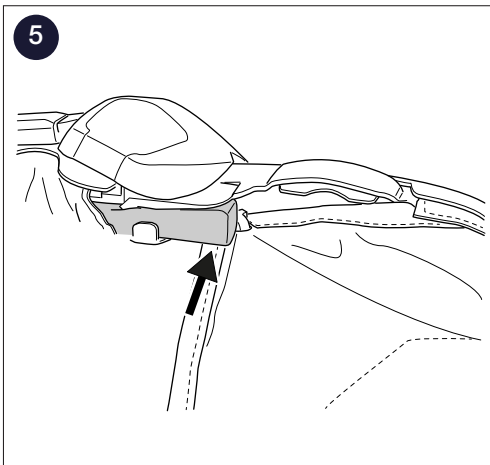
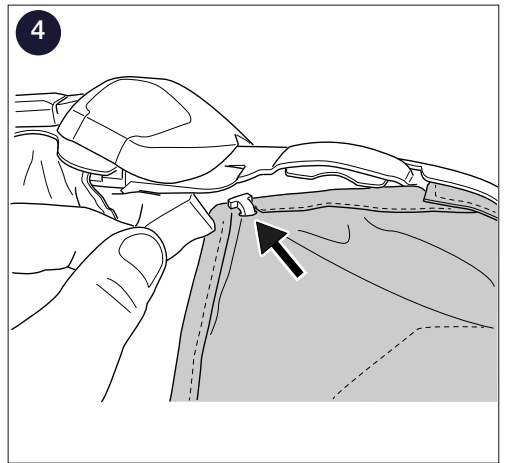
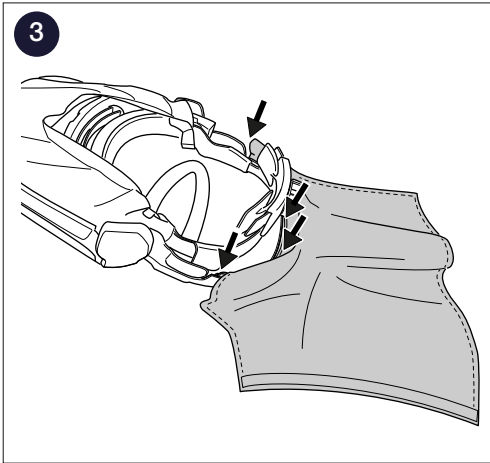
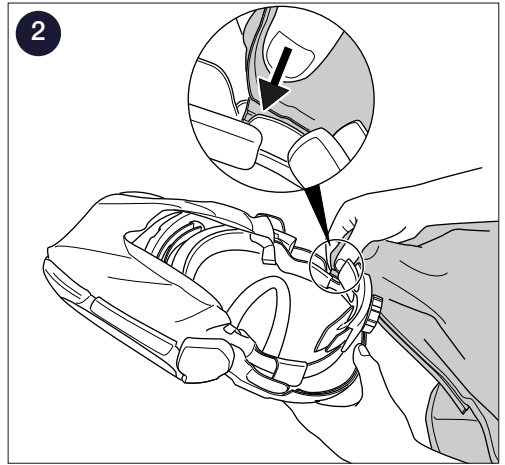
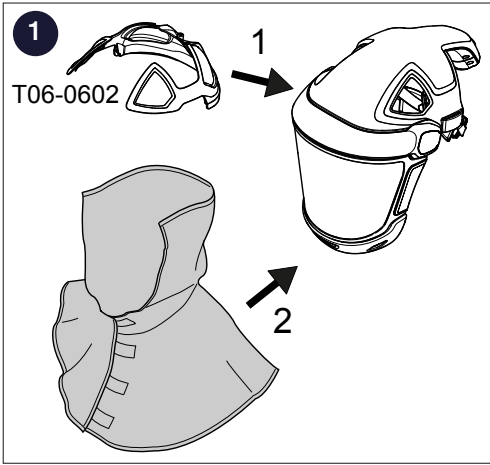

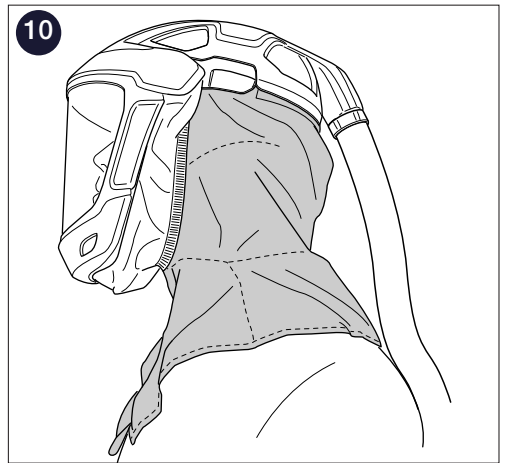
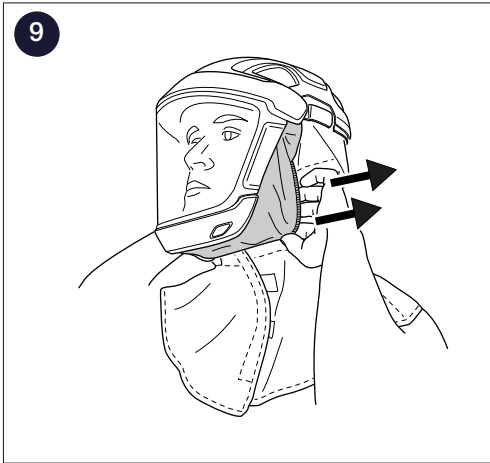
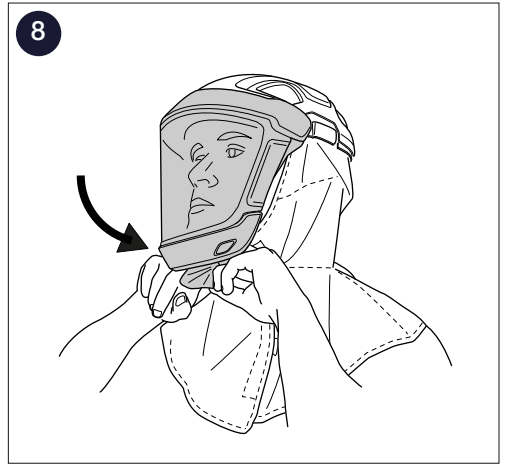
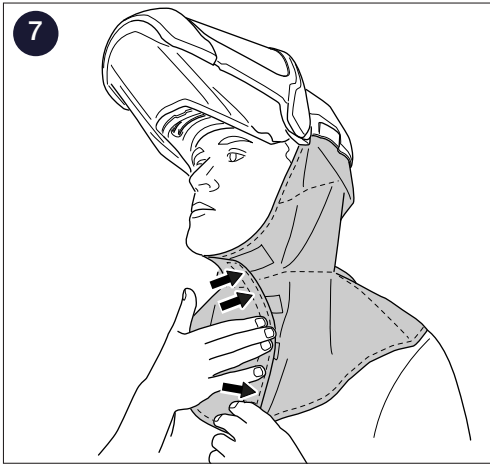



Sundström Safety AB

SE-341 50 Lagan • Sweden

Tel: +46 10 484 87 00

info@srsafety.se • www.srsafety.com

Cover with thread and knob for SR 570, T06-0640

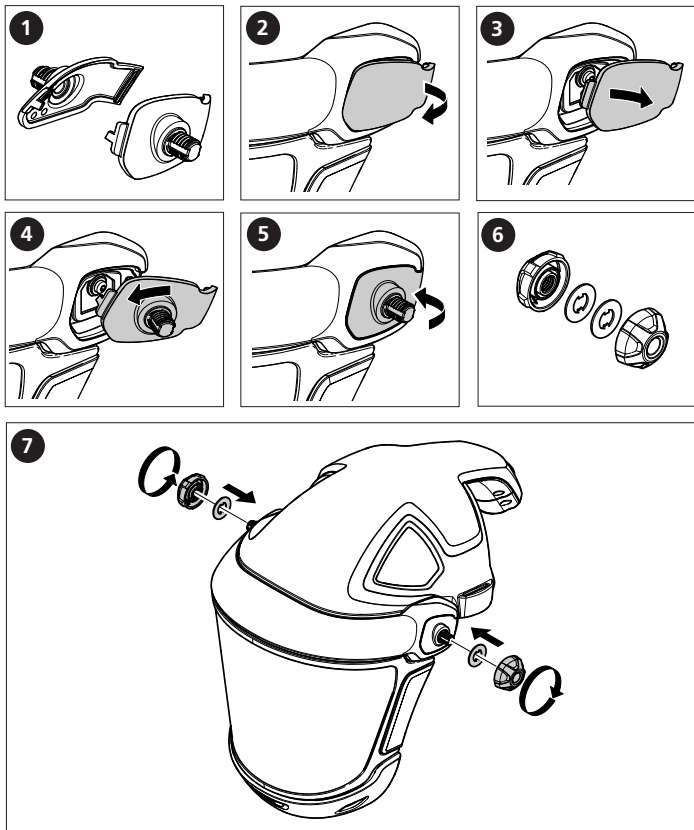

Sundström 

Sundström Safety AB

SE-341 50 Lagan • Sweden

Tel: +46 10 484 87 00

info@srsafety.se • www.srsafety.com



Shield 2/3 shade EN 3 for SR 570, T06-0609

Shield 2/3 shade EN 5 for SR 570, T06-0605

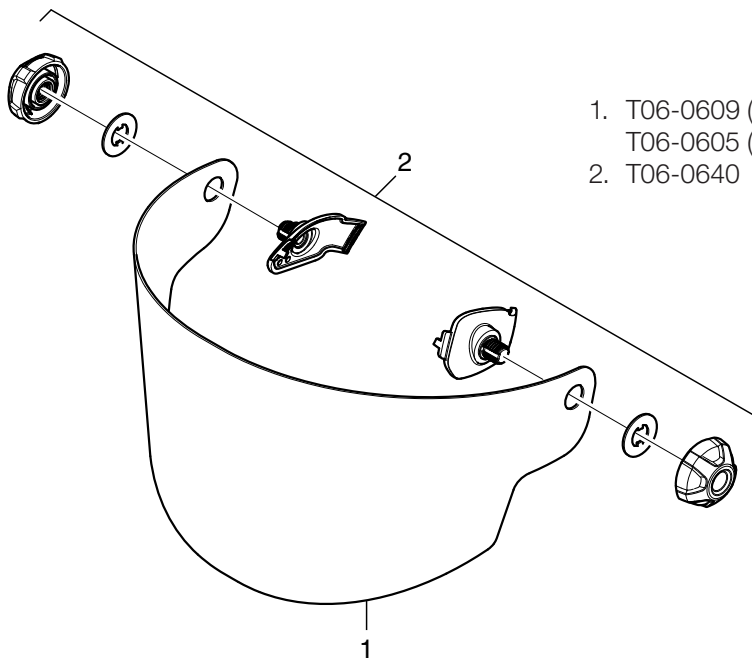

1. T06-0609 (EN 3)
T06-0605 (EN 5)
2. T06-0640

1

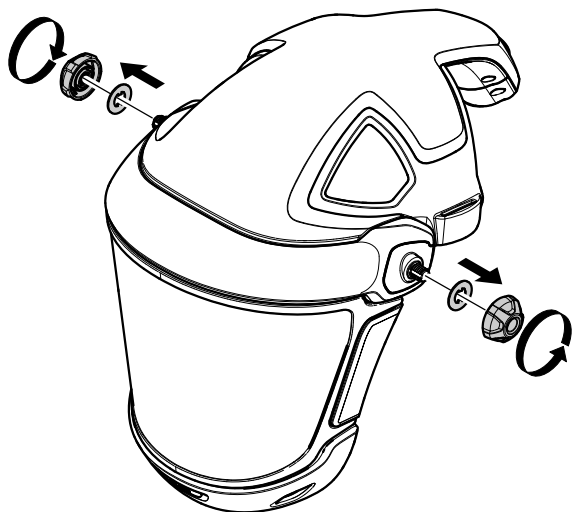

2





Sundström Safety AB

Västergatan 4 • SE-341 50 Lagan • Sweden

Tel: +46 10 484 87 00

info@srsafety.se • www.srsafety.com

Product leaflet

Product	Model No.	Ordering No.
Powered air purifying respirator	SR 500	H06-0112

Product Description

The SR 500 is a battery-powered fan that, together with a filter and an approved head top, is included in the Sundström fan-assisted respiratory protective device systems. The SR 500 can be used as an alternative to filter respirators in all situations in which these are recommended. This applies particularly to work that is hard, warm or of long duration.

The human interface may consist of a hood, face shield, half mask or full face mask. The fan is equipped with a filter, and the filtered air is fed through a hose to the human interface. The pressure then generated prevents surrounding pollutants from penetrating into the mask.

The characteristics of the SR 500 are as follows:

The battery is of lithium-ion type • Two battery alternatives, i.e. STD (Standard 2.2 Ah) and HD (Heavy Duty 3.6 Ah) • The charging time for the Standard battery is around 1.5 hours and for the Heavy Duty battery, about 2 hours • Equipped with two filters/combined filters • Operating time of up to 13 hours • The same control is used for starting, stopping and selection of operating status • Display with symbols • Equipped with automatic air flow control with compensation for air pressure and temperature • Can be used together with hoods SR 520, SR 530, SR 561, SR 562, face shield SR 540, half mask SR 900, full face mask SR 200, welding shield SR 590, helmet with visor SR 580 or welding shield/helmet with visor SR 584/SR 580.

Electronics ingress protection is approved in IP class IP67 according to IEC / EN 60529.

The SR 500 is also available in an explosion-protected version designated the SR 500 EX for use in a potentially explosive atmosphere (ATEX Directive 94/9/EC). See the separate product leaflet.

Technical specification

	SR 500	EN 12941:1998 + A2:2008	EN12942:1998 + A2:2008
Air flow, min/max	175/240 l/min	≥ 120 l/min	-
STD-battery/HD-Battery	14.8V, 2.2 Ah/3.6 Ah	-	-
Operating times at 175/240 l/min:			
P3, STD-battery	8 h (7 h ³)/5 h (4 h ³)	≥ 4 h	≥ 4 h
P3, HD- battery	13 h (12 h ³)/8 h (7 h ³)	≥ 4 h	≥ 4 h
Weight with STD-battery and P3 filter	≈ 1 350 g	≤ 3,500 g	≤ 3,500 g
Service conditions	-10 °C to +55 °C, < 90% RH, 600 to 1200 hPa	-	-
Storage conditions	-20 °C to +40 °C, < 90% RH	-	-
Low flow warning level	< 175 l/min	≤ 175 l/min	≤ 175 l/min
Assigned Protection Factor¹: SR 520, SR 530, SR 540, SR 561/562, SR 580, SR 584, SR 590	40 (TH3)	-	-
Assigned Protection Factor¹ SR 200	40 (TM3)	-	-
Nominal Protection Factor² SR 520, SR 530, SR 540, SR 561/562, SR 580, SR 584, SR 590	500 (TH3)	-	-
Nominal Protection Factor² SR 200	2000 (TM3)	-	-
Approvals	EN 12941:1998 + A2:2008 EN 12942:1998 + A2:2008	-	-

1) Specified in BS 4275 and applies generally to all approved fan-assisted respiratory protective devices, regardless of the test results.

2) According to EN 529:2005.

3) SR 900 + SR 951/SR 952.



Head Office

Tel: +46-(0)8-562 370 00
Fax: +46-(0)8-562 370 20

Visiting address:
Stockholmsvägen 33
SE-181 33 Lidingö

Factory

Tel: +46-(0)8-562 370 00
Fax: +46-(0)8-562 370 60

Visiting address:
Västergatan 4
SE-341 50 Lagan

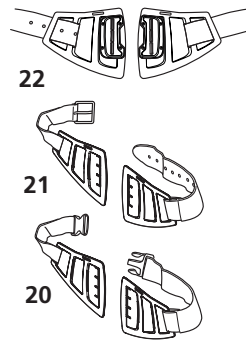
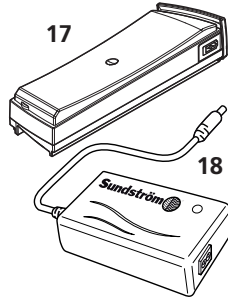
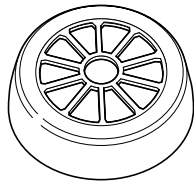
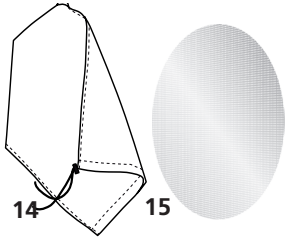
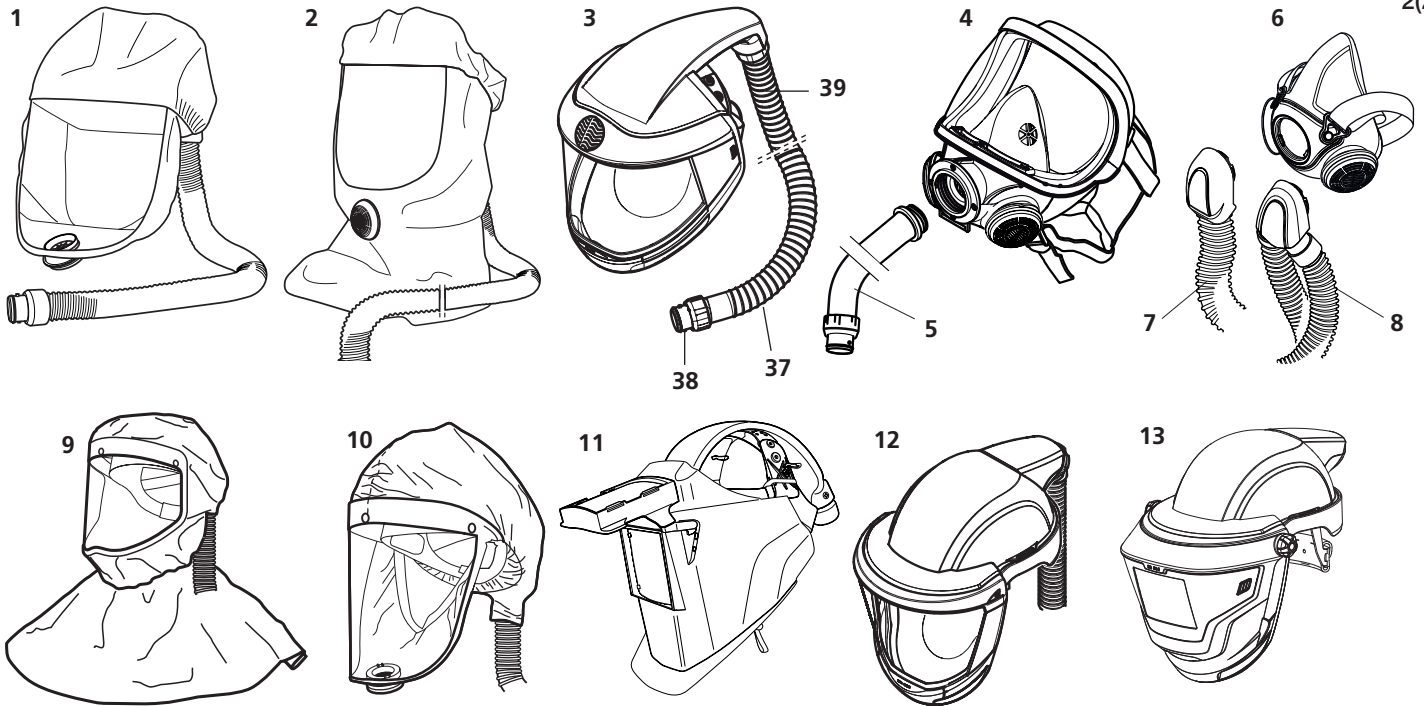

Head-tops, spare parts and accessories

Item

No. Part	Ordering No.
1. Hood SR 520 M/L	H06-0212
1. Hood SR 520 S/M	H06-0312
2. Hood SR 530	H06-0412
3. Face shield SR 540	H06-0512
4. Full face mask SR 200, PC visor	H01-1212
4. Full face mask SR 200, glass visor	H01-1312
5. PU hose SR 550 for SR 200	T01-1216
5. Rubber hose SR 551 for SR 200	T01-1218
6. SR 900 S	H01-3012
6. SR 900 M	H01-3112
6. SR 900 L	H01-3212
7. Hose SR 951	T01-3003
8. Twin hose SR 952	R01-3009
9. Hood SR 561	H06-5012
10. Hood SR 562	H06-5112
11. Welding shield SR 590	H06-4012
12. Helmet with visor SR 580	H06-8012
13. Welding shield/Helmet with visor SR 584/SR 580	H06-8310
14. Flow meter SR 356	R03-0346
15. Steel net disc SR 336	T01-2001
16. Asbestos Kit SR 509	T06-0105
17. Battery SR 501, 2,2 Ah	R06-0108
17. Battery HD SR 502, 3,6 Ah	T06-0101
18. Battery charger SR 513	R06-0103
19. Charging station without chargers SR 506	T06-0108
19. Charging station, complete SR 516	T06-0111
20. Belt SR 508	R06-0101
20. Rubber belt SR 504	T06-0104
21. Leather belt SR 503	T06-0103
22. HD belt SR 553, standard	T06-0119
22. HD belt SR 553, large	T06-0120
23. Harness SR 552	T06-0116
24. Fan SR 500, bare	R06-0110
25. Splash cover SR 514	T06-0114
26. Storage bag SR 505 w two compartments	T06-0102
27. Pre-filter holder SR 512	R06-0106
28. Pre-filter SR 221	H02-0312
29. Particle filter P3 R, SR 510	H02-1312
30. Filter adapter SR 511	R06-0105
31. Pre-filter holder SR 5153 for SR 710	R01-0604
32. Particle filter P3 R, SR 710	H02-1512
33. Gas filter A2, SR 518	H02-7012
34. Gas filter ABE1, SR 515	H02-7112
35. Gas filter A1BE2K1, SR 597	H02-7212
36. Combined filter A1BE2K1-Hg-P3 R, SR 599	H02-7312
37. Hose SR 541 for SR 540	R06-0501
38. O-ring for breathing hose	R06-0202
39. Flat gasket for hose SR 541	R06-0506
40. Gasket for fan	R06-0107
41. Plug kit	R06-0703

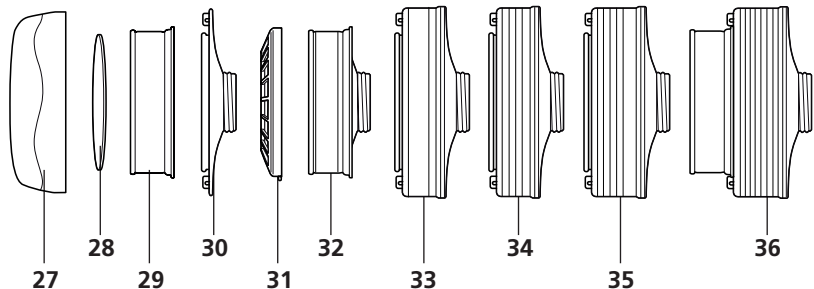
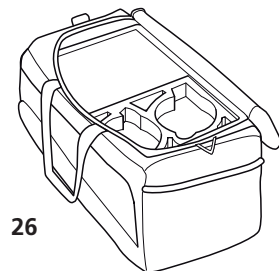
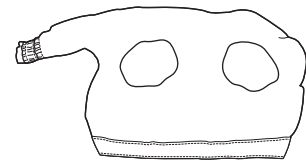
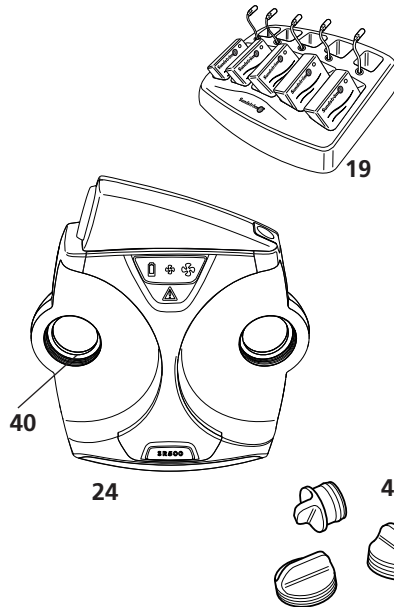

SR 500

EN

Spare parts / Accessories

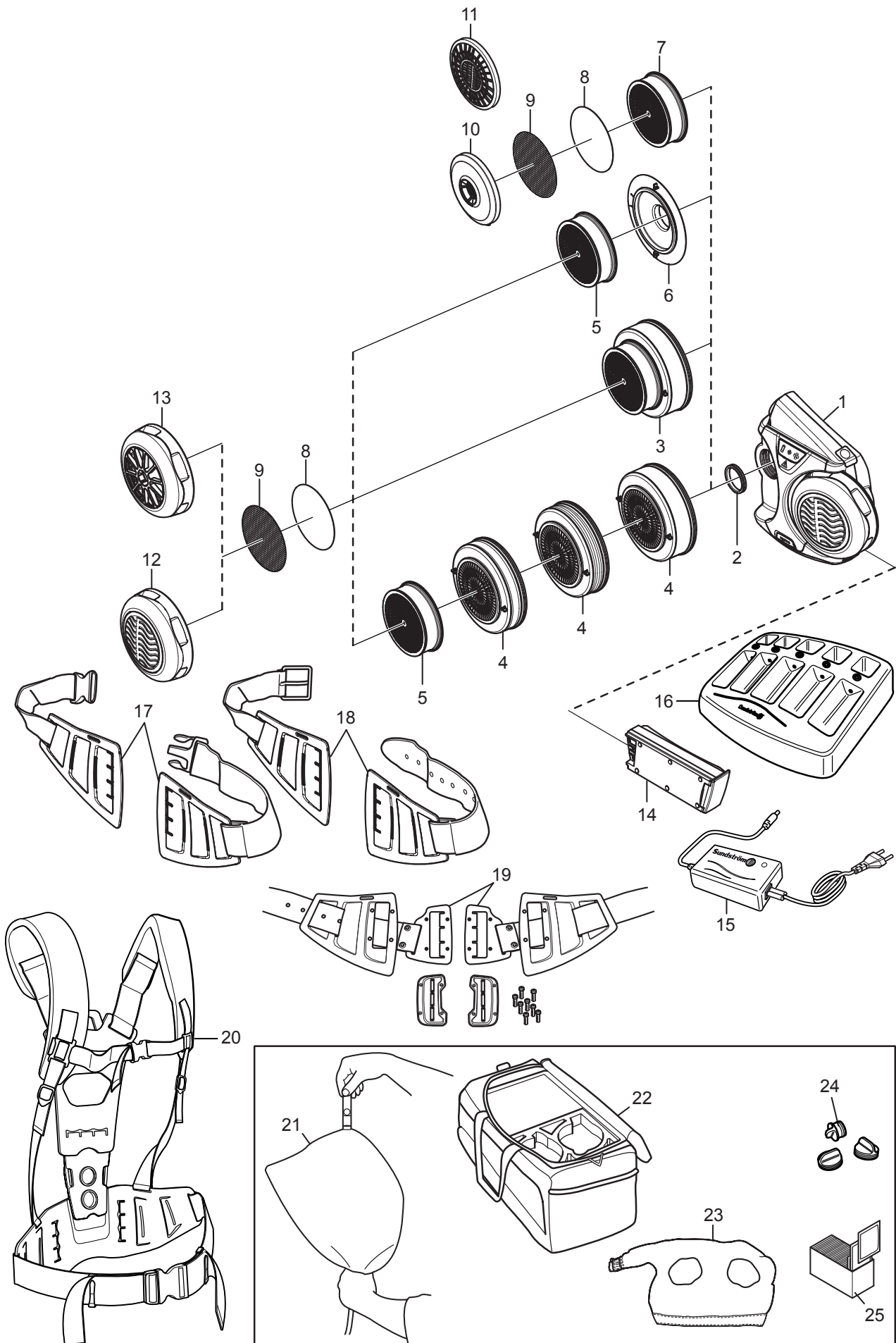

No.	Description	Ordering No.
1.	Fan unit SR 500, bare	R06-0110
2.	Gasket	R06-0107
3.	Combined filter A1BE2K1-Hg-P3 R, SR 599	H02-7312
4.	Gas filter A1BE2K1, SR 597	H02-7212
	Gas filter ABE1, SR 515	H02-7112
	Gas filter A2, SR 518	H02-7012
5.	Particle filter P3 R, SR 510	H02-1312
6.	Filter adapter SR 511	R06-0105
7.	Particle filter P3 R, SR 710	H02-1512
8.	Pre-filter SR 221	H02-0312
9.	Steel net disc SR 336	T01-2001
10.	Pre-filter holder	R01-0605
11.	Pre-filter holder SR 5153	R01-0604
12.	Pre-filter holder SR 512	R06-0106
13.	Asbestos kit SR 509	T06-0105
14.	STD Standard battery, 2,2 Ah	R06-0108
	HD Battery, 3,6 Ah	T06-0101
15.	Battery charger SR 513	R06-0103
16.	Charger stand SR 506	T06-0108
	Charger and chargerstand SR 516	T06-0111
17.	Belt PES SR 508	R06-0101
	Rubber belt SR 504	T06-0104
18.	Leather belt SR 503	T06-0103
19.	HD belt SR 553, standard	T06-0119
	HD belt SR 553, large	T06-0120
20.	Harness SR 552	T06-0116
21.	Flow meter SR 356	R03-0346
22.	Storage bag SR 505	T06-0102
23.	Splash cover SR 514	T06-0114
24.	Plug kit	R06-0703
25.	Cleaning wipes 50/box	H09-0401